

STR Group

SimuLED:
Engineering tool for LED
and laser diode design and optimization

2011

About Semiconductor Technology Research

Semiconductor Technology Research Group (STR) provides consulting services and offers specialized software for modeling of crystal growth, epitaxy, and semiconductor devices operation. STR employs highly qualified specialists capable of solving a wide range of practical problems related to semiconductor technology.

A comprehensive research underlies every consulting activity and software product which enables careful validation of physical models and approaches applied. STR's expertise in the crystal growth science and device engineering is accumulated in variety of publications in the peer-reviewed journals.

Four product lines are developed and promoted by STR:

- Bulk crystal growth from the melt
- Bulk crystal growth from the gas phase
- Epitaxy and deposition
- Operation of advanced semiconductor devices

Modeling of growth from the melt includes detailed 3D simulation of flow dynamics and heat transfer in the reactor. Such growth techniques as Czochralski (Cz), Liquid Encapsulated Czochralski (LEC), Vapor Pressure Controlled Czochralski (VCz), Kyropoulos, Bridgman, and Floating Zone of Si, GaAs, InP, SiGe, sapphire, etc are under study.

Simulation of growth of widebandgap semiconductors (SiC, AlN, GaN) from the gas phase considers heat and mass transport in the reactor, crystal shape evolution, and stress and defects dynamics.

Simulation of epitaxy and deposition of various materials (Si, SiC, III-V and III-Nitride compounds) includes flow dynamics and heat transfer, diffusion, gas-phase and surface chemistry, particle formation, and parasitic deposition on reactor units.

Modeling of advanced semiconductor devices concerns operation of LEDs, FETs, Schottky diodes, laser diodes, photodetectors, etc. Employed approaches allow prediction of device characteristics and optimization of heterostructure and chip design.

Every STR's product line is represented by a number of commercial software tools for industrial and research applications. 10 basic products in several editions for various semiconductor materials and growth techniques are offered today on the market. Over 50 industrial companies and academic institutions worldwide are the end-users of STR software.

There are several local distribution centers of STR software:

- STR Group, Ltd., Saint-Petersburg, Russia (<http://www.str-soft.com>)
- STR US, Inc., Richmond, VA, USA (<http://www.semitech.us>)
- STR GmbH, Erlangen, Germany (<http://www.strgmbh.de>)
- SimSciD Corporation, Yokohama, Japan (<http://www.simscid.co.jp>)
- Pitotech Co., Ltd., Chang Hua City, Taiwan (<http://www.pitotech.com.tw>)
- INFOTECH, Inc., South Korea (<http://www.infotc.co.kr>)

Simulation approach and package structure

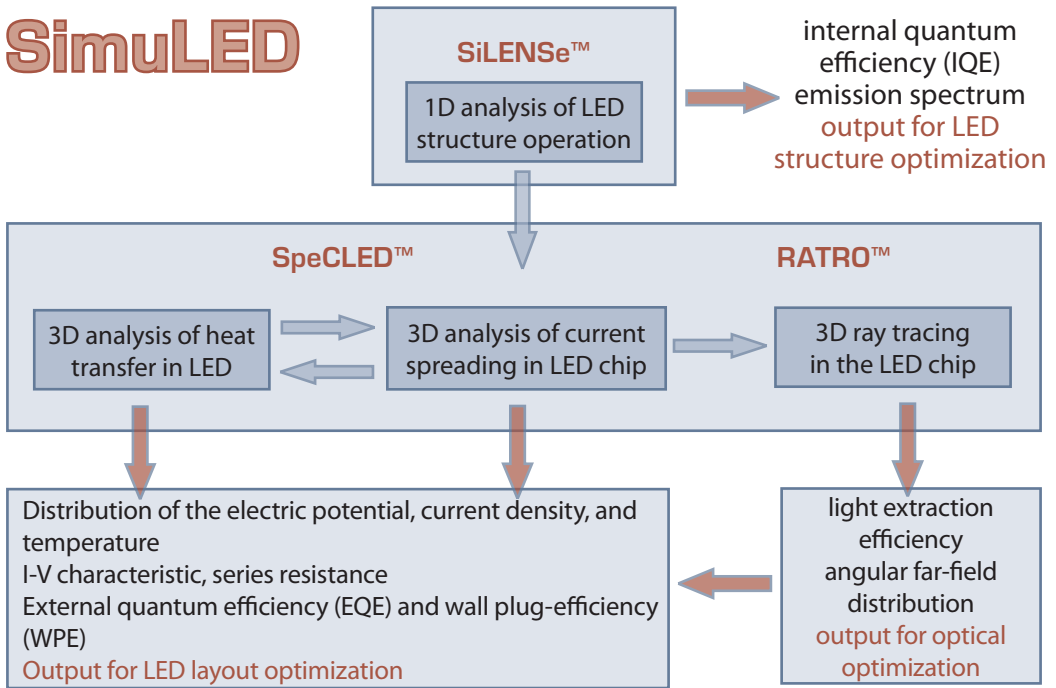

SimuLED: coupled software tools for LED modeling

SiLENSe –

1D simulator of carrier injection and light generation in wurtzite III-N and II-O LED/LD heterostructures

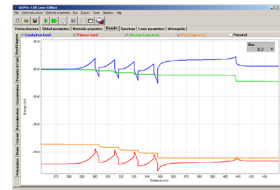

SpeCLEd –

3D simulator of current spreading and heat transfer in LED dice

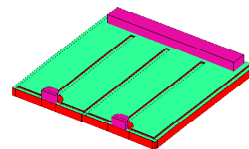

RATRO –

3D ray-tracing analyzer of light propagation and extraction in LED dice

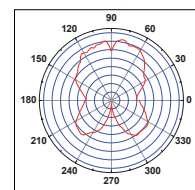

SiLENSe: Software for development and optimization of LED/laser diode heterostructures

- ▶ Band diagram
- ▶ Carrier concentrations
- ▶ Electric potential, electric field
- ▶ Radiative and non-radiative recombination rates
- ▶ Internal quantum efficiency
- ▶ Carrier fluxes
- ▶ Electron and hole energy levels in QWs
- ▶ Emission and gain spectra
- ▶ Built-in editable database of materials properties

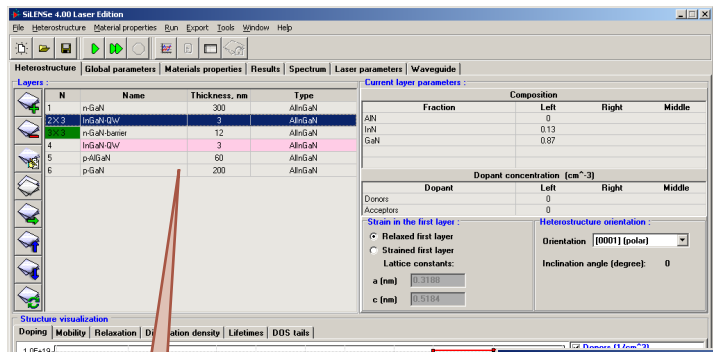
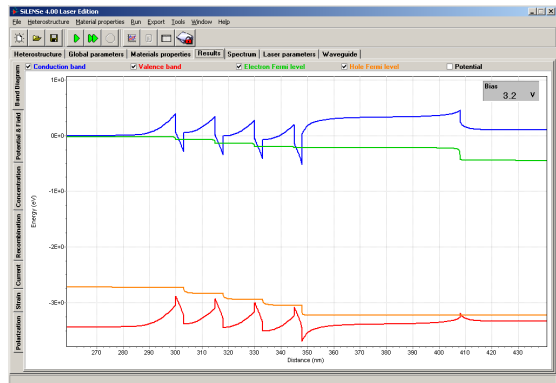

Specification of individual layer parameters: thickness, doping, and composition including graded composition materials

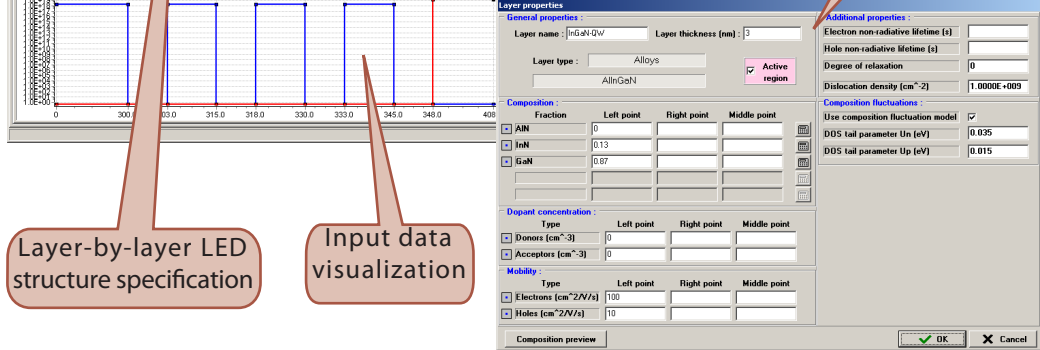

Layer-by-layer LED structure specification

Input data visualization

SiLENSe: 1D simulator for LED heterostructures

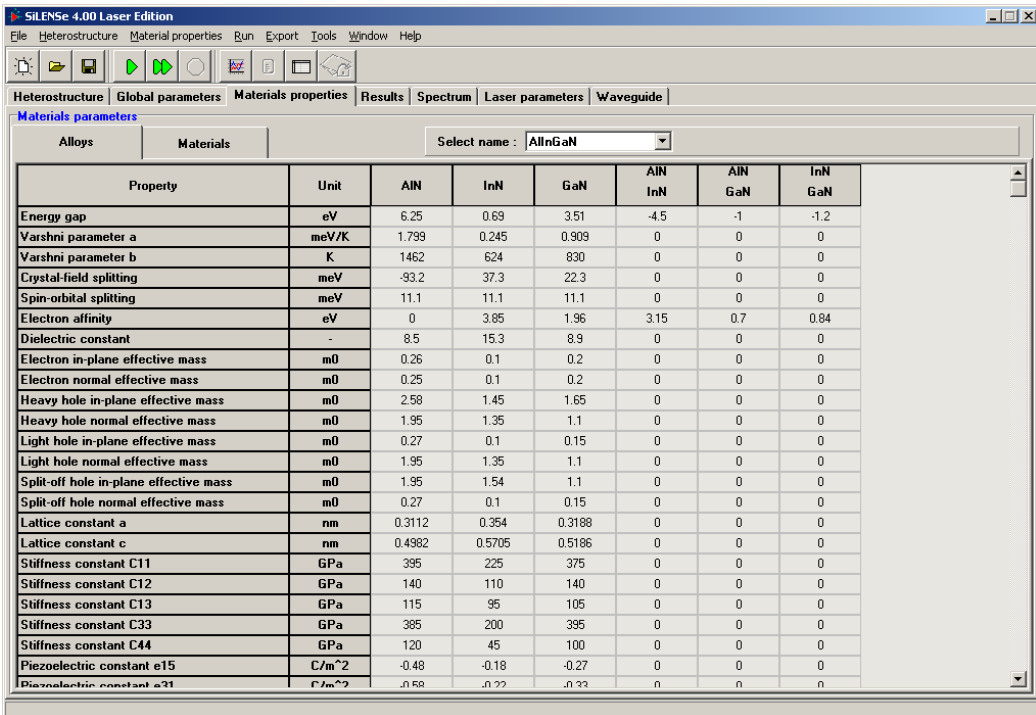

Property	Unit	AlN	InN	GaN	AlN InN	AlN GaN	InN GaN
Energy gap	eV	6.25	0.69	3.51	-4.5	-1	-1.2
Varshni parameter a	meV/K	1.799	0.245	0.909	0	0	0
Varshni parameter b	K	1462	624	830	0	0	0
Crystal-field splitting	meV	-93.2	37.3	22.3	0	0	0
Spin-orbital splitting	meV	11.1	11.1	11.1	0	0	0
Electron affinity	eV	0	3.85	1.96	3.15	0.7	0.84
Dielectric constant	-	8.5	15.3	8.9	0	0	0
Electron in-plane effective mass	m0	0.26	0.1	0.2	0	0	0
Electron normal effective mass	m0	0.25	0.1	0.2	0	0	0
Heavy hole in-plane effective mass	m0	2.58	1.45	1.65	0	0	0
Heavy hole normal effective mass	m0	1.95	1.35	1.1	0	0	0
Light hole in-plane effective mass	m0	0.27	0.1	0.15	0	0	0
Light hole normal effective mass	m0	1.95	1.35	1.1	0	0	0
Split-off hole in-plane effective mass	m0	1.95	1.54	1.1	0	0	0
Split-off hole normal effective mass	m0	0.27	0.1	0.15	0	0	0
Lattice constant a	nm	0.3112	0.354	0.3188	0	0	0
Lattice constant c	nm	0.4982	0.5705	0.5186	0	0	0
Stiffness constant C11	GPa	395	225	375	0	0	0
Stiffness constant C12	GPa	140	110	140	0	0	0
Stiffness constant C13	GPa	115	95	105	0	0	0
Stiffness constant C33	GPa	385	200	395	0	0	0
Stiffness constant C44	GPa	120	45	100	0	0	0
Piezoelectric constant e15	C/m ²	-0.48	-0.18	-0.27	0	0	0
Piezoelectric constant e31	C/m ²	-0.58	-0.22	-0.33	0	0	0

Editable database of materials properties

SiLENSe: Competitive advantages

- ▶ Advanced physical models
 - ▷ Polar/nonpolar/semipolar heterostructures
 - ▷ Distributed polarization doping in graded- composition AlGaIn and InGaIn alloys
 - ▷ Original model of non-radiative recombination at dislocations
 - ▷ Original model of IQE increase in InGaIn QWs due to carrier localization in In-rich composition fluctuations
- ▶ Easy to learn: it requires ~1-2 days to start simulations after installing the package
- ▶ Fast operation: the simulator allows full analysis of ~5-10 heterostructures a day
- ▶ SiLENSe is helpful not only for device engineers but also for people doing epitaxial growth of LED and LD heterostructures

SiLENSe: Simulation of blue MQW LED heterostructure

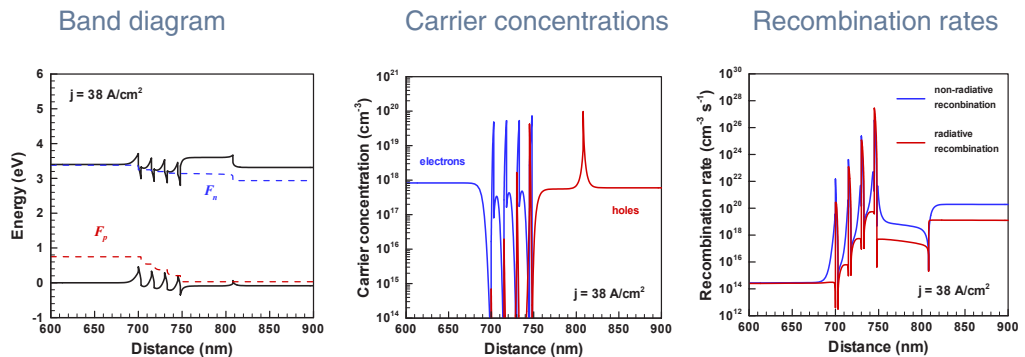
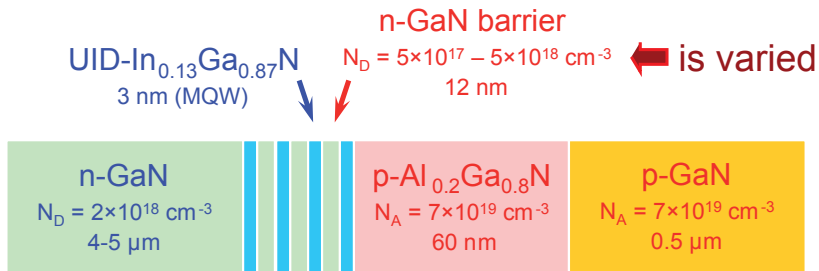

Factors affecting the internal quantum efficiency

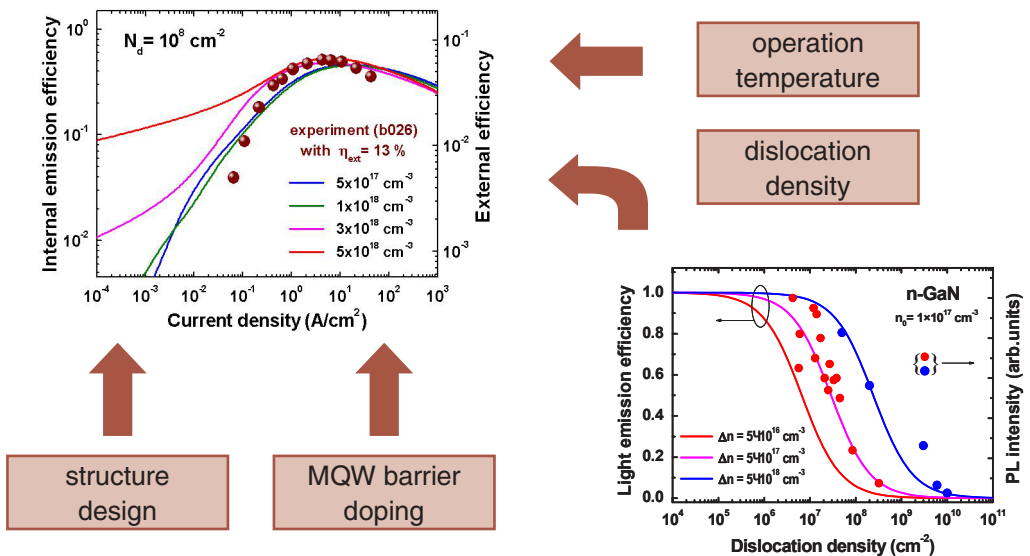

SiLENSe: Simulation of hybrid ZnO/AlGaN LED heterostructure

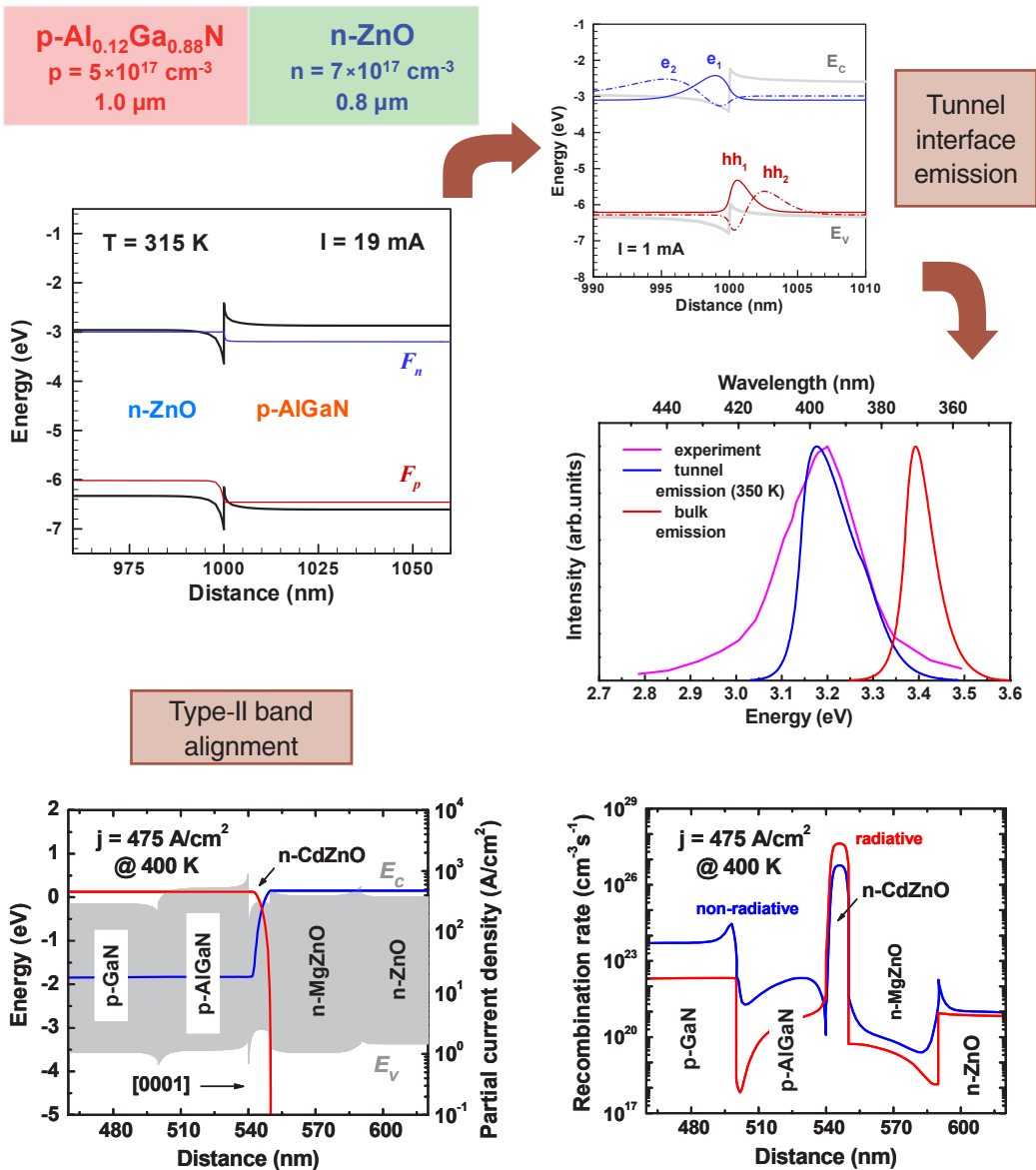

Simulations show that hybrid II-O/III-N DHS LEDs provide a high IQE even at elevated operation temperatures. Excellent carrier confinement can be obtained in a CdZnO active region.

SiLENSe Laser Edition: Simulation of UV laser diode

Combined with the main functionality of the SiLENSe software, new features support complex optimization of the laser diodes.

- ▶ **Computation of the waveguide TE and TM modes**
 - ▷ Advanced approximation of the refractive index dispersion in nitride materials
 - ▷ Birefringence is taken into account
- ▶ **Computation of the optical gain and loss**
 - ▷ Computation of the gain spectrum and optical confinement factor for each quantum well
 - ▷ Optical loss because of the free carriers
- ▶ **Threshold characteristics**
 - ▷ Threshold current density, differential quantum efficiency

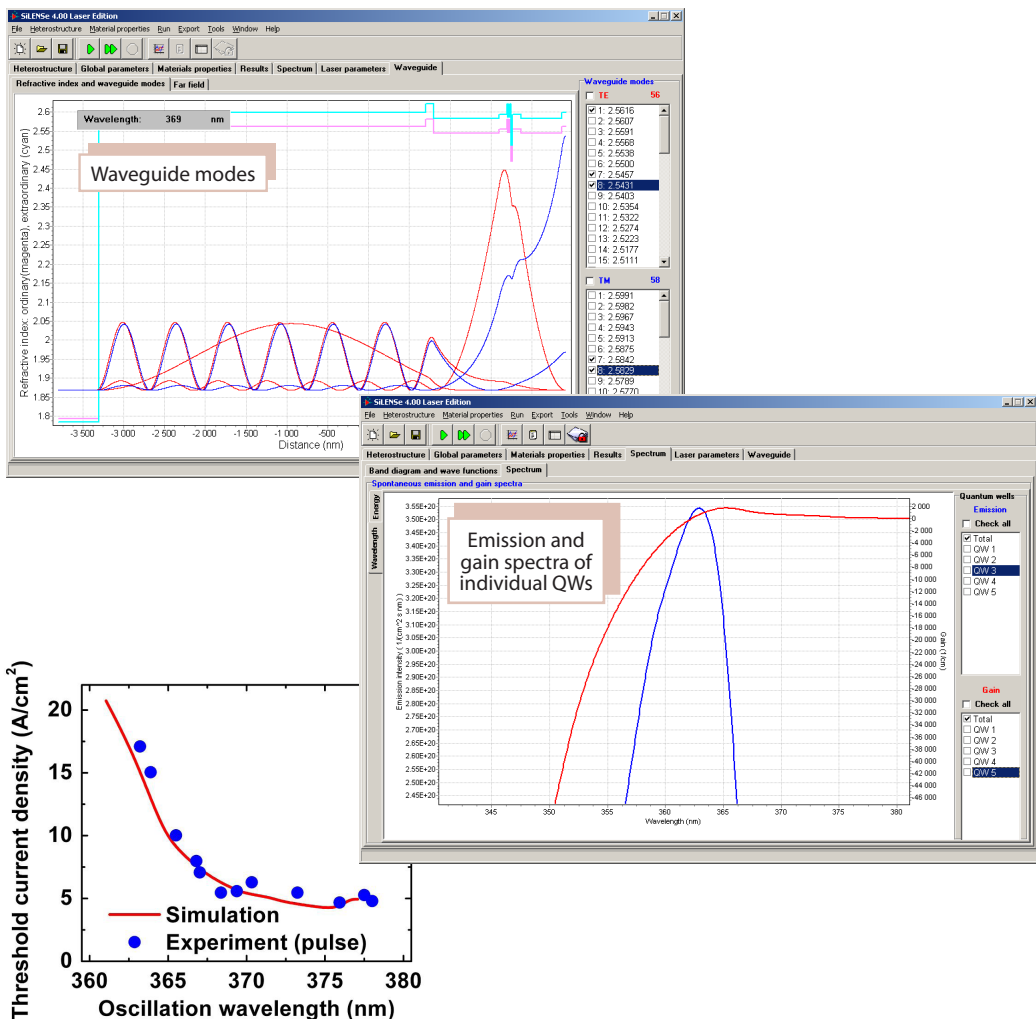

SpeCLED: Package for development and optimization of LED dice

3D coupled computation of the current spreading and heat transfer provides the following information:

- ▶ 3D distributions of the electric potential, current density, and temperature in the whole die
- ▶ 2D distributions of the p-n junction bias, current density, internal quantum efficiency, and temperature in the active region plane
- ▶ I-V characteristic, series resistance, emission spectrum, external quantum efficiency and wall-plug efficiency

SpeCLED: Hybrid 3D/1D approach to current spreading problem

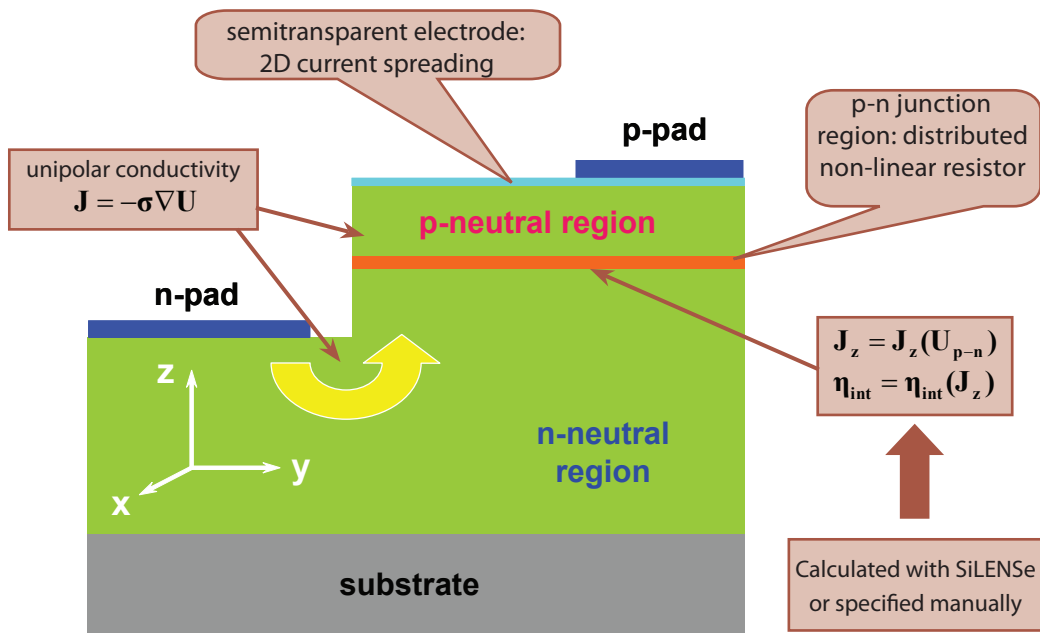

SpeCLED: Competitive advantages

- ▶ Self-consistent 3D analysis of the current spreading and heat transfer
- ▶ Hybrid 3D/1D approach makes computations much faster keeping the essential physics
- ▶ User-friendly interface
 - ▷ Easy geometry specification
 - ▷ Automatic grid generation
 - ▷ Built-in visualization of simulation results

SpeCLED: Easy geometry specification

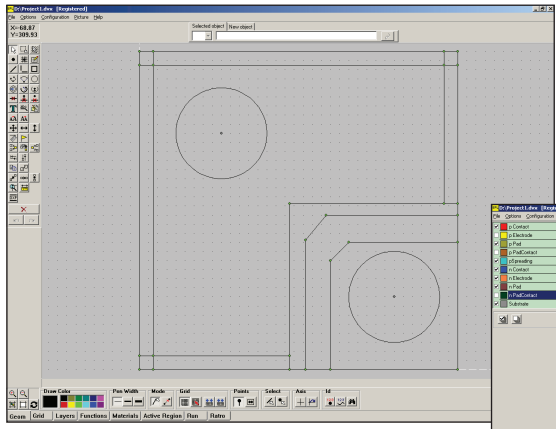

Input 2D layout ...

... and get 3D geometry!

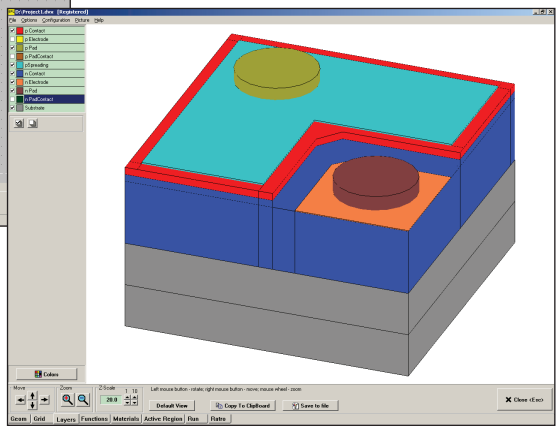

SpeCLED: Automatic grid generation

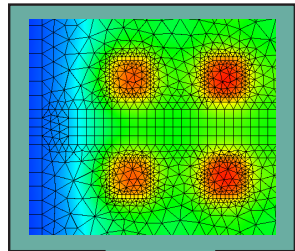

Square-LED: unstructured 3D grid with 85 000 cells

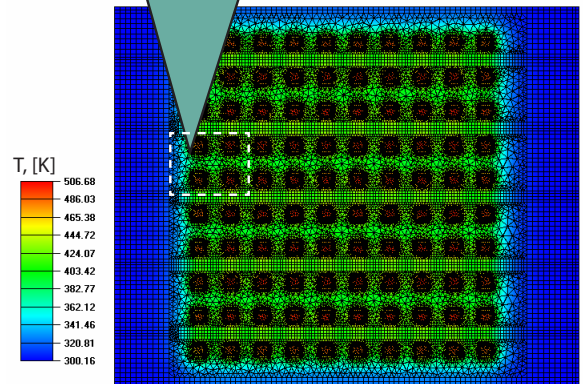
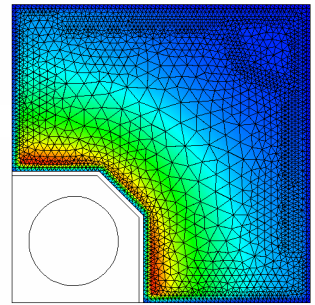
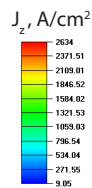

Multi-pixel LED: 3D grid with 1 100 000 cells combining structured and unstructured meshes

Application example: Planar LED with simple contact configuration

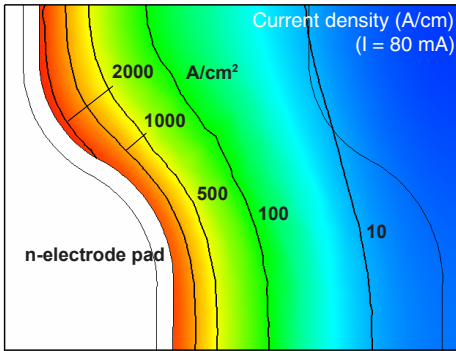

Current crowding occurring at the electrode edge produces a very non-uniform in-plane distribution of the emission intensity

A local overheating depends on the current density and die configuration

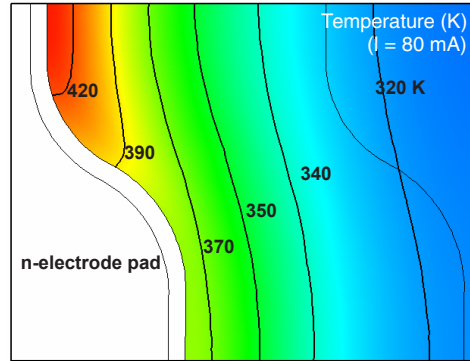

Application example: High-power flip-chip mounted LED

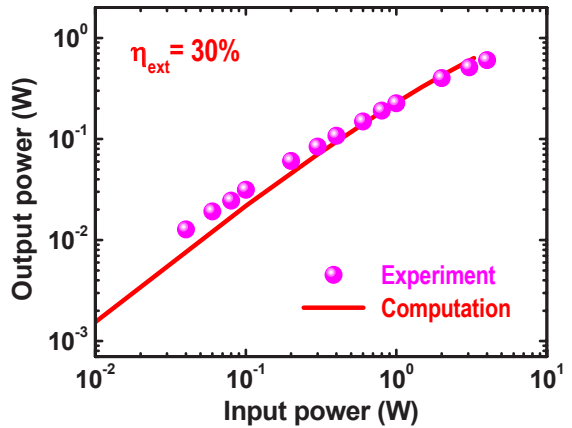
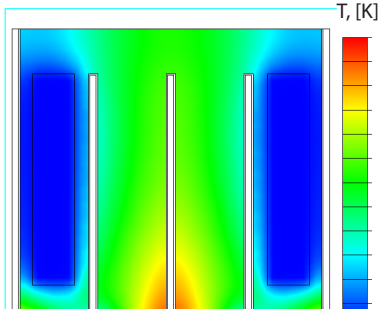
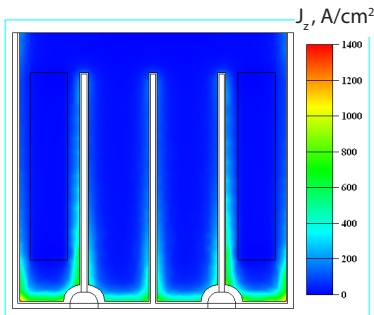

RATRO: Module for optical design and optimization of LED dice

Competitive advantages:

- ▶ Flexible specification of light interaction with internal and external surfaces: smooth and patterned surfaces, mirrors, antireflective coatings, and DBRs
- ▶ Account of lateral non-uniformity of light emission from the active region (if used in combination with SpeCLED)
- ▶ Original model of light scattering on surfaces patterned with hexagonal or rectangular pyramids or holes
- ▶ Various die configurations, including shaped substrate
- ▶ Analysis of light polarization

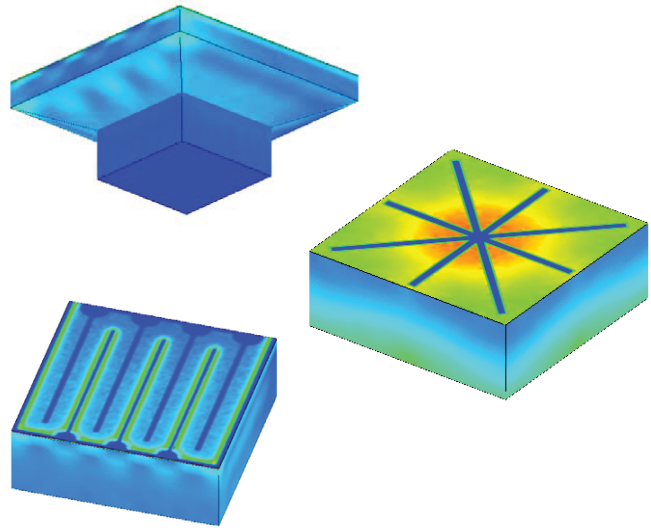
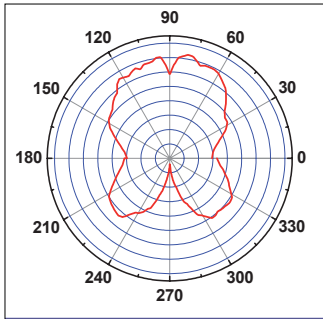

Output light intensity at planar LED die surfaces

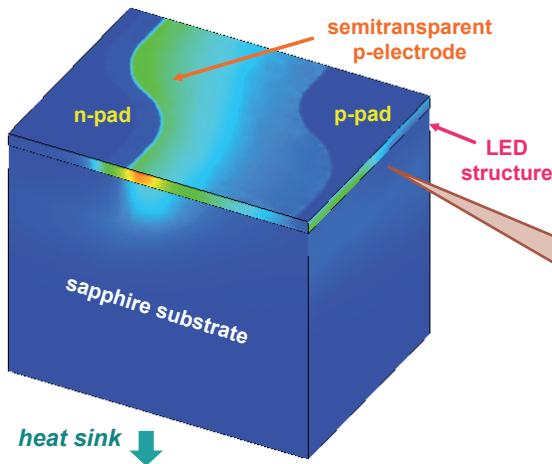

Waveguiding leads to light extraction through the side walls of sapphire substrate

SimuLED: Analysis of Thin-Film LED operation

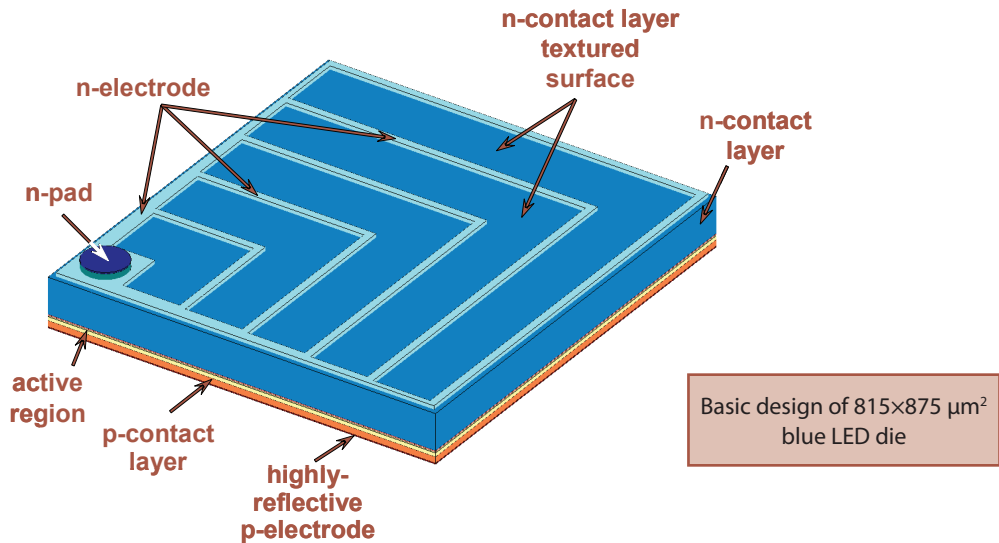

Output light intensity at planar LED die surfaces

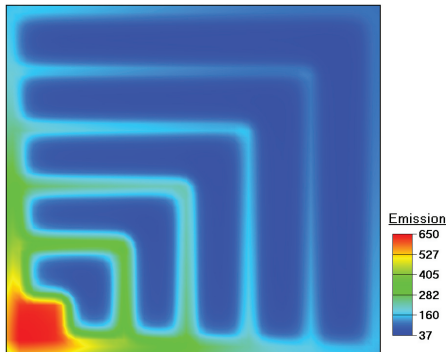

Maximum of light generation is located under/next to n-electrode. However, light generation under the n-pad does not contribute at all to the extracted light

Two approaches including optimization of the electrode layout and optimization of current spreading were suggested for improvement of Light Extraction Efficiency

Performance improvement at the current of 700 mA:

LEE \uparrow from 60 to 70%

V_f remains the same

Optical power \uparrow from 530 to 635 mW (by 20%)

WPE \uparrow from 23 to 28%

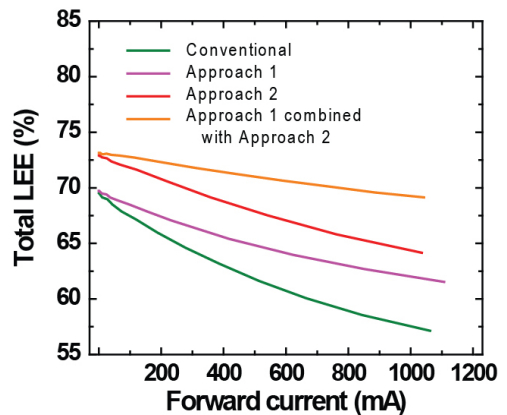

SimuLAMP: Software for Optical and Thermal Management of LED Lamps

Main options and effects considered

- ▶ Heat transfer in a specified complicated lamp geometry
- ▶ Heat release in the LED chip
- ▶ Heat release in phosphor due to light absorption
- ▶ Light conversion in individual phosphor and phosphor mixtures
- ▶ Mie theory for light absorption and scattering by phosphor particles ★ NEW
- ▶ Detailed IV characteristics and WPE of particular LED chip is imported from SimuLED

Output

- ▶ Temperature distribution, thermal resistance
- ▶ Near-field and far-field intensity distribution
- ▶ Output light spectrum, color uniformity
- ▶ CRI, CCT and other characteristics of white color
- ▶ Efficacy, WPE

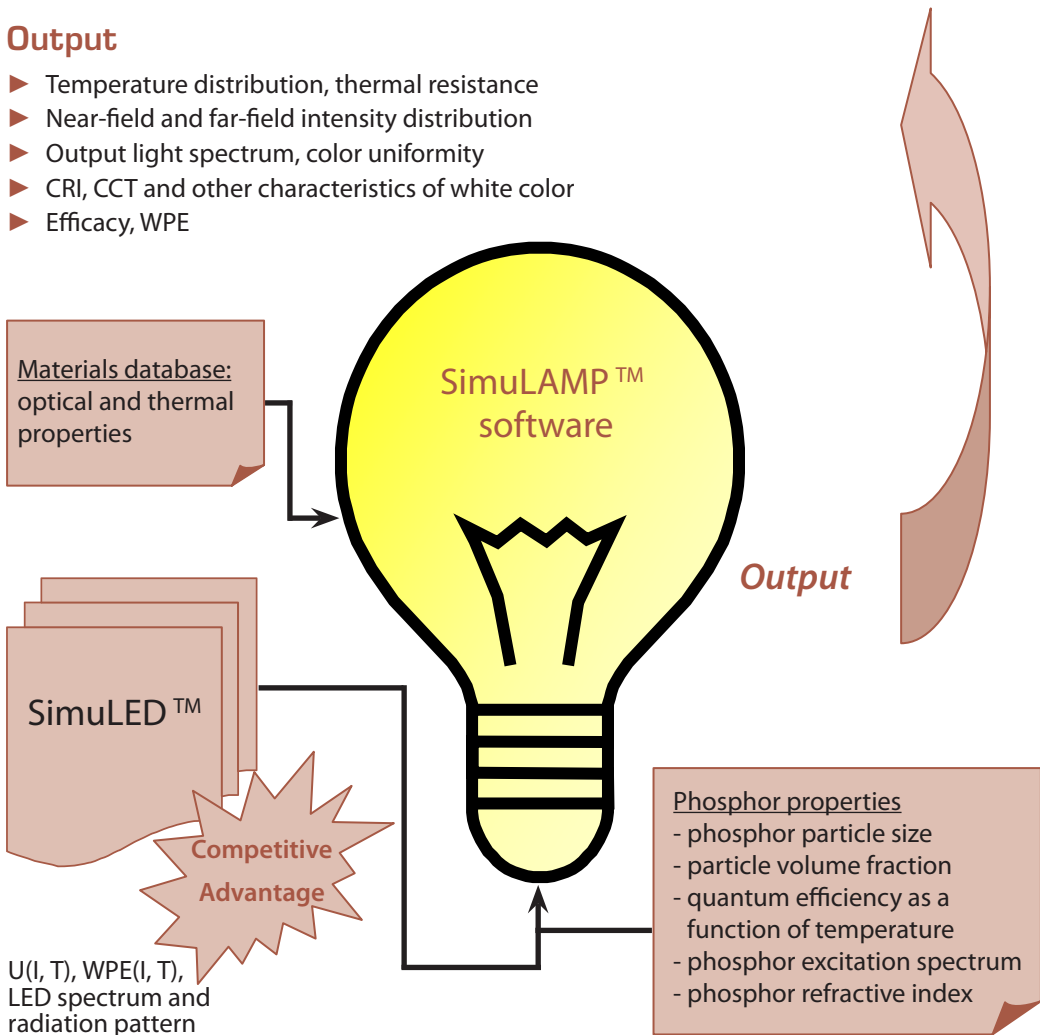

SimuLAMP: Temperature distribution in the LED Lamp

Automatic grid generation

- ▶ Structured, unstructured, and combined grids are supported
- ▶ Mismatched grids are available

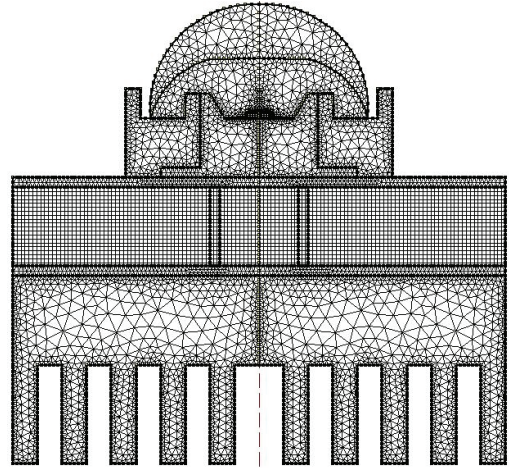
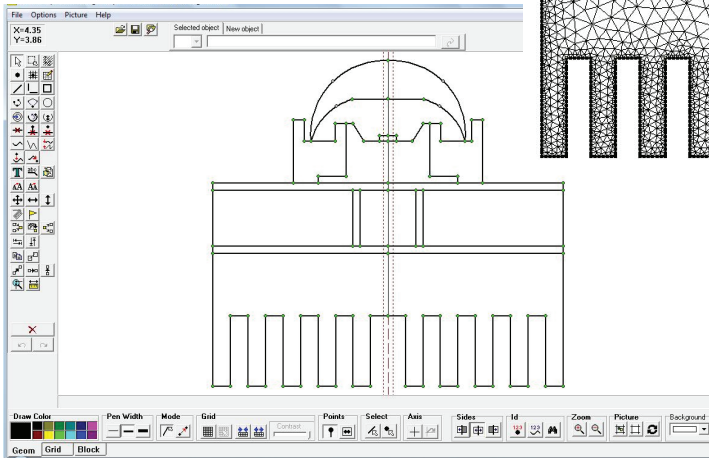

Geometry specification

SimuLAMP is used to study the effect of

- ▶ LED design
- ▶ Materials properties
- ▶ Heat sink design can be tested via "what if" scenario

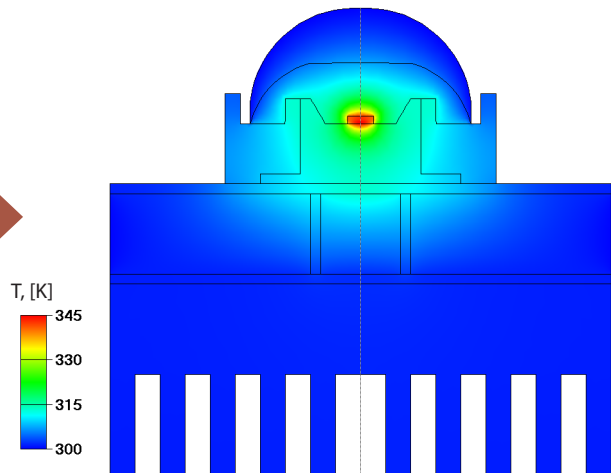

SimuLAMP: Near-field intensity distribution

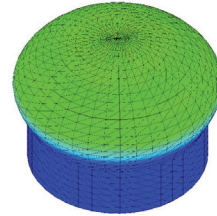
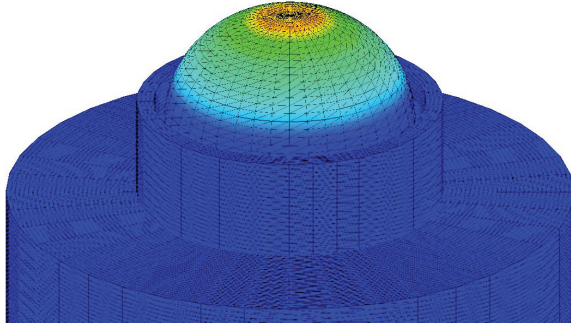

Near-field intensity distribution predicted in various lamp designs

SimuLAMP: Far-field intensity distribution

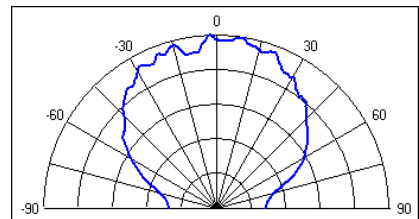
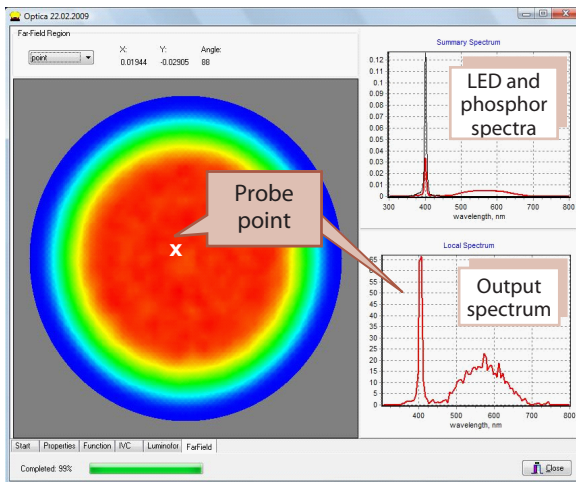

↑
 Probe tool for analysis of color uniformity

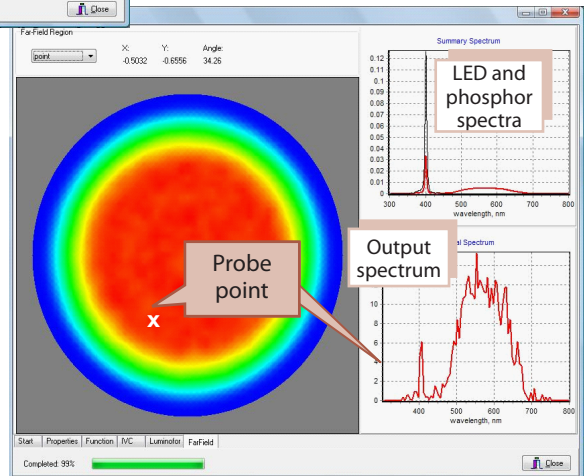

Testimonials

«I'm happy to be reference for the SiLENSe program. We have been very happy with the ease of the user interface, and the underlying physical models are comprehensive. We have been particularly impressed by the ability to include parameters for materials other than for the GaN system into the database, which has helped our development work on ZnO-based LEDs. We look forward to a long association with this excellent software package.»

Prof. Steve Pearton, Department of Materials Science and Engineering, University of Florida, USA

«I think SiLENSe is very useful not only as an educational tool for students, but also as a designing tool to optimize blue-LED structures. We are planning to apply this very effective tool to optimize UV LED structures.»

Prof. Hiroshi Amano, Department of Materials Science and Engineering, Meijo University, Nagoya, Japan

«We are using it and we like it.»

Prof. Stanislaw Krukowski, Institute of High Pressure Physics, Polish Academy of Sciences, Warsaw, Poland

«Your code is useful and the simulations have good agreement with experimental results. Last year the results of simulations have been reported on two conferences.

Prof. Sergey Nikishin, Texas Tech University, Electrical & Computer Engineering, Lubbock, TX, USA

«SiLENSe (Simulator of Light Emitters based on Nitride Semiconductor) is an excellent software tool for user, especially for the beginner of the simulation and modeling. It supports the user-friendly interface that even if a person who has no idea about programming can run this simulator. This software based on the simulation of nitride (especially GaN) light emitting diode (LED). But it can also be applied to other materials system such as ZnO-based LED.»

Dr. Sang Youn Han, Department of Materials Science and Engineering, University of Florida, USA

Selected Publications:

▶ GaN-based devices

- ▶ Sergey Yu. Karpov, "Modeling of III-nitride Light-Emitting Diodes: Progress, Problems, and Perspectives", Proc. of SPIE, vol. 7939 (2011), "Gallium Nitride Materials and Devices VI", Eds. J.-I. Chyi, Y. Nanishi, H. Morkoç, J. Piprek, and E. Yoon.
- ▶ M.V. Bogdanov, K. A. Bulashevich, O.V. Khokhlev, I. Yu. Evstratov, M. S. Ramm, and S. Yu. Karpov, "Current crowding effect on light extraction efficiency of thin-film LEDs", Phys. Stat. Solidi (c) 7 (2010), 2124–2126.
- ▶ M.V. Bogdanov, K. A. Bulashevich, O.V. Khokhlev, I. Yu. Evstratov, M. S. Ramm, and S. Yu. Karpov, "Effect of ITO spreading layer on performance of blue light-emitting diodes", Phys. Stat. Solidi (c) 7 (2010), 2127–2129.
- ▶ K.A. Bulashevich, M.S. Ramm, and S.Yu. Karpov, «Effects of electron and optical confinement on performance of UV laser diodes», Phys. Stat. Solidi (c) 6 (2009) 603.
- ▶ M.V. Bogdanov, K.A. Bulashevich, I.Yu. Evstratov, A.I. Zhmakin, and S.Yu. Karpov, «Coupled modeling of current spreading, thermal effects, and light extraction in III-Nitride light-emitting diodes», Semicond. Sci. Technol. 23 (2008) 125023.
- ▶ K. A. Bulashevich, S. Yu. Karpov, "Is Auger recombination responsible for the efficiency rollover in III-nitride light-emitting diodes?", Phys. Stat. Solidi (c) 5 (2008) 2066–2069.
- ▶ S. Yu. Karpov, «Visible Light-Emitting Diodes», In: Nitride Semiconductor Devices: Principles and Simulation, Ed. J. Piprek, WILEY-VCH Verlag GmbH & Co. KGaA, Weinheim, Ch.14 (2007) 303-325.
- ▶ S.Yu. Karpov and Yu.N. Makarov, «Dislocation Effect on Light Emission Efficiency in Gallium Nitride», Appl. Phys. Lett. 81 (2002) 4721-4723.

▶ ZnO-based devices

- ▶ A. Osinsky and S. Karpov, «ZnO-Based Light Emitters», In: Zinc Oxide. Bulk, Thin Films and Nanostructures, Eds. C. Jagadish and S.J. Pearton, Elsevier, Ch.15 (2006) 525-554.
- ▶ K.A. Bulashevich, I.Yu. Evstratov, and S.Yu. Karpov, «Hybrid ZnO/III-nitride light-emitting diodes: modelling analysis of operation», Phys. Stat. Solidi (a) 204 (2007) 241-245.
- ▶ J.W. Mares et. al., «Hybrid CdZnO/Ga quantum-well light emitting diodes», J. Appl. Phys. 104 (2008) 093107.

▶ Conventional III-V devices

- ▶ K. A. Bulashevich, V. F. Mymrin, and S. Yu. Karpov, D M Demidov, and A L Ter-Martirosyan, «Effect of free carrier absorption on performance of 808 nm AlGaAs-based high-power laser diodes», Semicond. Sci. Technol. 22 (2007) 502-510.



STR Group, Ltd.
Engels av. 27, P.O. Box 89, 194156
Saint-Petersburg, Russia
Tel: +7 (812) 603 2652
Fax: +7 (812) 326 6194
www.str-soft.com
e-mail: simuled-support@str-soft.com